



# Combined refrigerated and heating bath circulator

ecocool 100R

Operating Manual

If you have any feedback on Grant's products or services, we would like to hear from you.  
Contact:

**Legal manufacturer**

Grant Instruments (Cambridge) Ltd  
Evolution House  
Unit 2, Durham Way  
Royston Gateway  
Royston  
SG8 5GX UK

Tel: +44 (0) 1763 260 811

E-mail: [support@grantinstruments.com](mailto:support@grantinstruments.com)

**Representative in the European Union**

Grant Instruments Europe B.V  
Strawinskylaan 411  
WTC, Tower A, 4th Floor  
1077 XX, Amsterdam  
The Netherlands

E-mail: [grant@eu.grantinstruments.com](mailto:grant@eu.grantinstruments.com)

**Country of Origin: UK**

# Contents

---

Contents	2
1.0 Use of products	4
2.0 How to use this operating manual	4
3.0 Safety information	5
3.1 Safety compliance	5
3.2 Safety symbols	5
3.3 Safety warnings	5
4.0 Operating instructions	6
4.1 Unpacking instructions	6
4.2 Product description	7
4.2.1 Heating Circulator	7
4.2.2 Refrigerated bath	9
4.3 Installation	11
4.4 Rotating the heating circulator	11
4.5 Fitting the communications lead	12
4.6 Electrical supply	12
4.7 Recommended liquids	13
5.0 Operating procedures	14
5.1 Preparing the ecocool 100R for use	14
5.1.1 Liquid level	14
5.1.2 Tank lid	14
5.1.3 Setting the over-temperature thermostat	14
5.1.4 Using the heating circulator pump	15
5.1.5 Emptying the liquid tank	15
5.1.6 Setting up and switching on	16
5.1.7 Eco mode cooling	16
5.2 Using the equipment	17
5.2.1 Setting the control temperature	17
5.2.2 Selecting liquid type	17
5.2.3 Configuring a pre-set	17
5.2.4 Running a bath preset	18
5.2.5 Setting a countdown timer	18
5.2.6 Cancelling the timer	19
5.2.7 Setting a high temperature warning alarm	19
5.2.8 Controlling the external pump power	19
5.2.9 Selecting cooling mode	20
5.2.10 Completing a calibration	20
5.2.11 Restoring factory calibration settings	21
5.2.12 Adjusting display brightness	21
6.0 Technical specifications	22
6.1 Operating conditions	22
6.2 Electrical details	22
6.3 Performance	22
6.4 Storage and transportation	22
7.0 Technical Tips	23
7.1 Which water should you use in your equipment?	23
7.2 How to prevent rust in the equipment	23
7.3 How to prevent algae and bacteria?	24
8.0 Warranty information	25
9.0 Maintenance and service	25
9.1 Routine maintenance	25
9.2 Cleaning	25
9.3 Fuses	26

9.5	Routine safety tests	26
9.6	Disposal	27
9.7	Service	27
10.0	Optional accessories	28
10.1	Alternative pump	28
10.2	Pump connectors and other accessories	28
11.0	Troubleshooting	30
12.0	Contact Grant Instruments	32
13.0	Compliance	33
	Notes	34



## 1.0 Use of products

---

The following products are covered by this operating manual:

- ecocool 100R
- ecocool 100R US

The products listed above are combined refrigerated and heating bath circulators designed for indoor laboratory use by or supervised by a professional user.

The ecocool 100R (*the equipment*) consists of a T ecocool 100R (*the heating circulator*) and an R ecocool 100R (*the refrigerated bath*). Both parts of the system are designed to work together and will not work independently or with other heating and refrigeration models.

The included insulated hoses and clips allow circulation of temperature-controlled fluids to external equipment.

## 2.0 How to use this operating manual

---

This operating manual will allow you to unpack, set-up and operate this refrigerated and heating bath circulator correctly and safely. Important safety information, symbols and warnings are listed below and should be read carefully before operating the product. Section 4 gives information about how to unpack and install the product correctly. Section 5 gives operating information for the equipment. Product technical specifications and tips are provided in sections 6 and 7. The warranty for this product is for THREE YEARS and should be registered by completing the on-line registration form which can be found at [www.grantinstruments.com](http://www.grantinstruments.com). Full details of warranty conditions can be found in section 8 of this manual

If you have any questions regarding the operation of the equipment, please contact your local distributor or Grant instruments who will be able to assist you with your enquiry.

## 3.0 Safety information

---

### 3.1 Safety compliance

The equipment meets the requirements of international safety standard IEC 61010: Safety requirements for electrical equipment for measurement, control, and laboratory use.

### 3.2 Safety symbols

The symbols below are marked on the equipment and throughout this manual to indicate:



Warning: Surface(s) and heat transfer liquid may be hot during and after use.



Read these instructions before installation or use of the ecocool 100R (*the equipment*)



Warning, hazard: read these instructions before proceeding to ensure you understand the nature of the hazard.



Warning: equipment contains a flammable refrigerant.

### 3.3 Safety warnings



Use only as specified by the operating instructions: if the equipment is used in a manner not specified by the manufacturer, the protection provided by the equipment may be impaired.



This equipment is only for indoor use by a professional user.



Use only water, water-glycol, or silicone oil with this equipment (see section 4.7 for more details). Do not inhale the vapours given off as they may be toxic. Liquids should be safely discarded and replaced.



Make sure the correct fluid type has been selected in the heating circulator and ensure that the fluid is only used within its specified temperature range.



Do not use the equipment with any sample material that could cause a fire or any other kind of hazard.



Do not use the equipment in an area where there are aggressive or explosive chemical mixtures.



It is the user organisation's responsibility to carry out appropriate decontamination if hazardous material is spilt on or inside the equipment.



Before moving, disconnect from the mains power supply.



If a warning message or warning light appears on the heating circulator display, do not touch the liquid or the tank, they may be very hot.



Do not touch surfaces which become hot during high temperature operation.



It is the user organisation's responsibility to carry out a risk assessment when operating this product within their own operating environment.



WARNING: Do not use mechanical devices or other means to accelerate defrosting: either turn the equipment off or set it to ambient temperature and wait until all the ice has melted.



WARNING: Do not damage the refrigerant circuit.

## 4.0 Operating instructions

---

### 4.1 Unpacking instructions

Standard equipment includes:

- ecocool100R refrigerated and heating bath circulator
- Ready to use 2 metre insulated hose kit
- 2 additional hose clips
- Mains cord with plug
- Mains link-cord for heating circulator - 230V equipment only
- Communications lead
- Safety information sheet



The equipment weighs 24kg. Take necessary precautions when lifting.

Remove packing materials carefully and retain them for future shipment or storage of the equipment.

## 4.2 Product description

### 4.2.1 Heating Circulator

Figure 1: Heating circulator front panel



#### Heating circulator indicators

There are two indicator lamps on the heating circulator:

- Heater on lamp (orange) marked  $\text{SSS}$
- Alarm lamp (red) marked  $!$

The alarm lamp will illuminate to indicate the following faults:

- Float switch has operated due to low liquid level
- Over temperature cut out has operated
- Temperature probe fault

The cause of the alarm will also be shown on the display.

The display normally shows the temperature of the liquid being controlled in  $^{\circ}\text{C}$

The **S**(et) button is used to select and store values whilst the **F**(unction) button is used to access menu options and cancel functions.

The Control dial is used to change temperature values and other user settable parameters.

**Figure 2: Heating circulator rear panel**

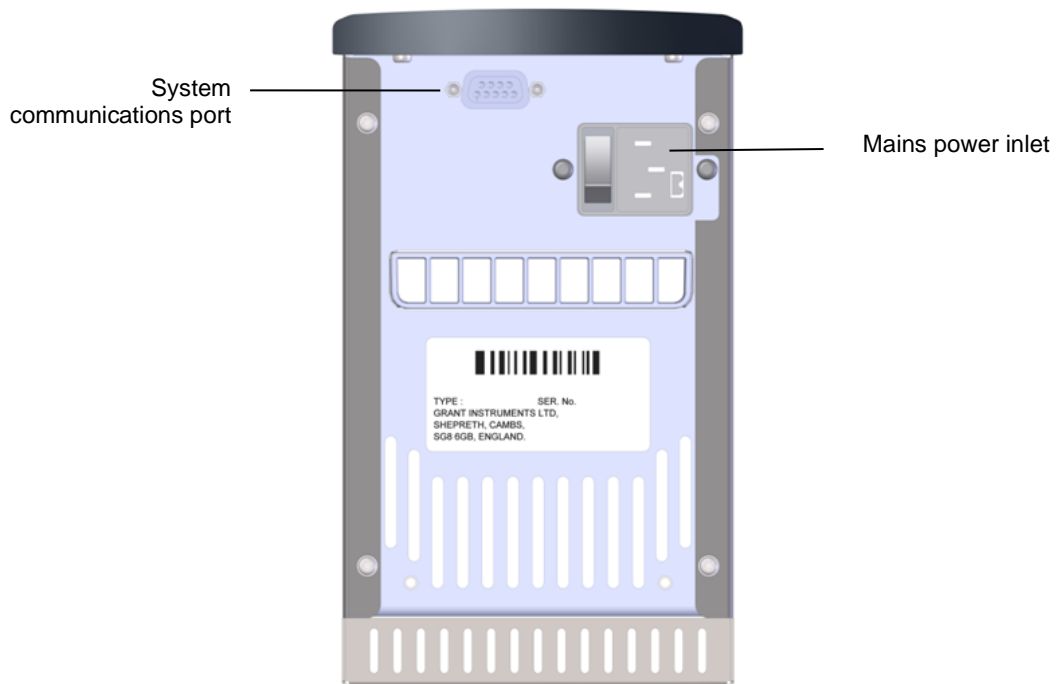

### **System Communications port**

The system communications port provides communications between the heating circulator and refrigerated bath. The communications cable should remain connected at all times.

Only use the communications port cable supplied with the system. Do not connect any other cables or equipment to this communication port

### **Mains Power cable inlet and switch**

For connection to the mains power outlet on the refrigerated bath. Use the mains link cord supplied with the system.

For 120V equipments there is a fixed mains cable with plug fitted for connection directly to a mains power outlet.

## 4.2.2 Refrigerated bath

Figure 3: Refrigerated bath front panel with condenser grille removed



### Drain port and drain insert

To access the drain port, pull out the top of the front grille and lift away.

The drain port and insert allow convenient emptying of the refrigerated bath. To drain the bath first remove the drain insert from the holder and connect a suitable length of hosing to the drain insert. Place the non-connected end of tubing in a receptacle, suitable for the liquid to be drained. Push the drain insert into the drain port and let the liquid drain. To release the drain insert push up the grey button on the drain port and extract the drain insert.



Liquid to be drained should not be below 10°C or above 50°C.

Although the drain has been designed for minimum leakage it is advisable to place an absorbent cloth under the drain port to catch any drips.

Always replace the front grille after draining.

### Power on/off switch

Push switch to power on and off the system

**Figure 4: Refrigerated bath rear panel (230V)**

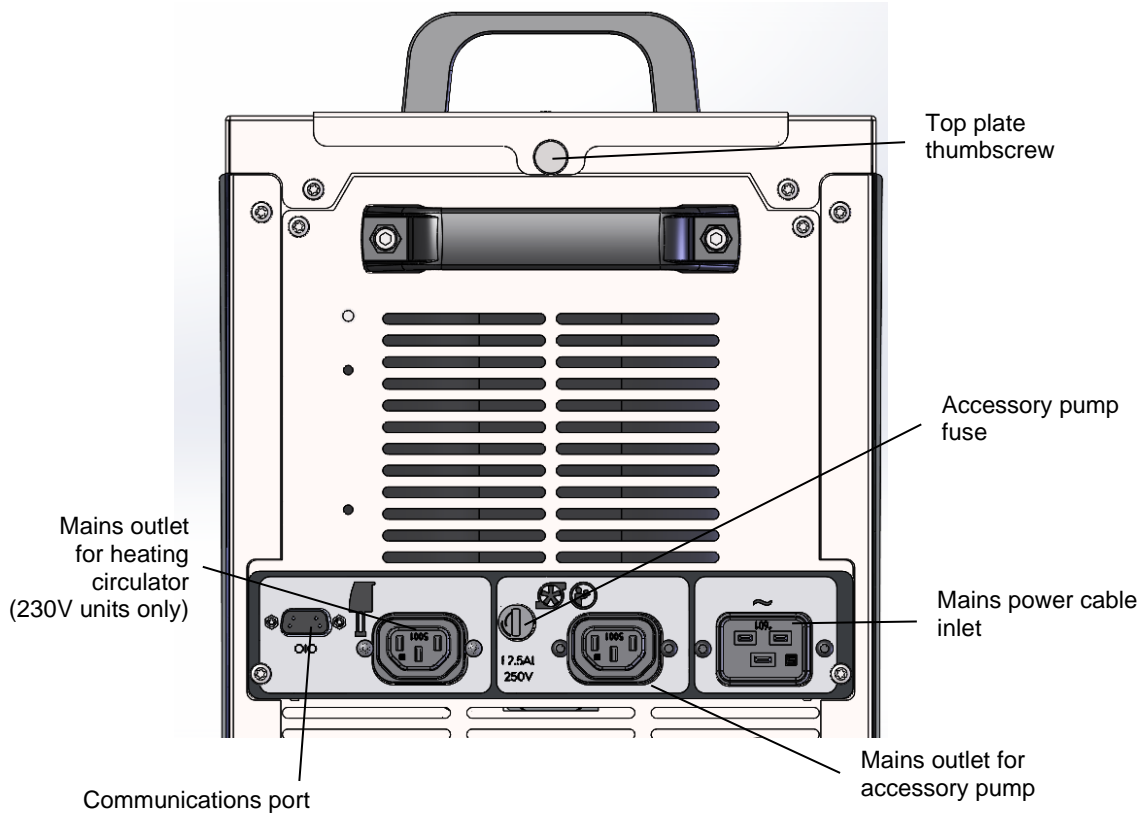

**Figure 5 Refrigerated bath rear connection panel (120V)**

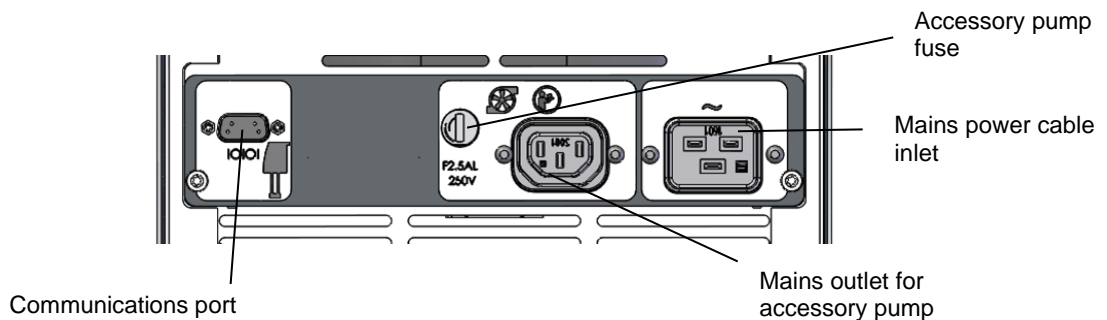

### Communications Port

The system communications port provides communications between the heating circulator and refrigerated bath. The communications cable should remain connected at all times.

Only use the communications port cable supplied with the system. Do not connect any other cables or equipment to this communication port.

### Mains power outlet for heating circulator (230V equipment only)

Provides power for 230V heating circulator. Use the mains link cord supplied with the equipment.

For 120V equipment, the heating circulator must be powered separately

### **Mains power outlet for accessory pump**

Optional power connection for an accessory pump. Power can be set ON using the Settings menu. See section 5.2.8

### **Mains power cable inlet**

For connecting the equipment to a mains power supply. Use the mains cord supplied with the system. See Section 4.6 for instructions

### **Top plate thumbscrew**

To remove the heating circulator from the refrigerated bath for cleaning, first unfasten this thumbscrew. Slide the top plate backwards and lift to completely remove the heating circulator.

## **4.3 Installation**

After transportation, let the equipment stand in its intended working position for six hours. This is to allow the oil to drain to the bottom of the compressor. This is normal procedure for refrigeration compressors.

Allow at least 100mm clearance from obstructions at the front and rear so that there is free air flow through the equipment.



Place the equipment on a firm, level surface. Ensure that the mains plug and the switch at the rear of the equipment are easily accessible.



After transport or storage in humid conditions, always allow the equipment to stand for at least an hour at room temperature before operating.



Do not block or restrict ventilation slots. Allow at least 100mm clearance from obstructions



Do not connect to a power supply or switch on before filling the tank.



Drain before moving the bath. Liquid to be drained should not be below 10°C or above 50°C.



Always operate the equipment with the condenser grille fitted.

## **4.4 Rotating the heating circulator**

The heating circulator is fitted ready to use with the pump ports facing the left-hand side. If required, the heating circulator can be rotated so the pump ports face the rear and the user controls are accessed from the left hand side.

Consider rotating the heating circulator, if following a risk assessment, access to hot surfaces needs to be reduced.

To rotate, remove the thumbscrew at the rear of the refrigerated bath and lift up the heating circulator and top plate. Remove the 2 thumbscrews from the underside of the top plate to release the heating circulator. Rotate the heating circulator on the top plate and refit.



#### 4.5 Fitting the communications lead

Connect the communications lead from the heating circulator to the refrigerated bath. The connecting ports are shown in Section 4.2 and figures 2 to 4. This enables the heating circulator to control the cooling power. If the lead is not connected correctly the heating circulator will display the fault 'EEO'.

#### 4.6 Electrical supply



Connect the equipment to a grounded (earthed) electrical power supply with voltage and frequency within the range specified on the serial number plate.



The equipment must only be connected to the mains using the mains cord supplied or one with an identical rating (see section 9.4)



Ensure the mains switch and isolating device (power supply connector) is easily accessible during use.

The method of connection of 230V equipment and 120V equipment differs: on 230V equipment, the heating circulator is supplied with mains power via a link cable from the refrigerated bath; on 120V equipment, the heating circulator has its own permanently attached power cable with a NEMA 5-15P plug suitable for North American outlets.

#### 230 V equipment

Connect the heating circulator using the mains link cable by plugging it into the “Mains power inlet” on the heating circulator (see figure 2) and the “mains outlet for heating circulator” on the refrigerated bath (see figure 4). Connect the equipment to the mains supply by plugging the mains supply lead into the “Mains power cable inlet” on the refrigerated bath (see figure 4) and a suitable mains power outlet in the building.

**CAUTION:** Take care not to plug the heating circulator into the “mains outlet for accessory pump” (see figure 4) as this will blow the replaceable accessory pump fuse. It won't cause any further damage, but it will cause inconvenience.

#### 120V equipment

Connect the heating circulator by plugging its fixed cord-set into a suitable mains power outlet in the building. Connect the refrigerated bath to the mains supply by plugging the mains supply lead into the “Mains power cable inlet” on the refrigerated bath (see figure 5) and a suitable mains power outlet in the building.

**CAUTION:** this equipment is designed to be connected to wall outlets with branch circuit protection. Use only the supplied mains cords or identical replacements. The heating circulator mains cord is not replaceable by the user (see section 9.4).

## 4.7 Recommended liquids

The following table lists the recommended liquids for different temperature ranges. Always ensure the liquid used is safe and suitable for your working temperature.

It is the user organisation's responsibility to assess the risks associated with the choice of heat transfer liquid chosen and to put in place safe working practises and appropriate protective equipment for personnel when considered necessary.



To ensure protection, the overtemperature cut-out must be set appropriately for the heat transfer liquid selected (see table below).



Use fume extraction when using silicone fluids at elevated temperatures

Temp range	Recommended liquid	Comments
-20°C to 50°C	50% water, 50% antifreeze (inhibited ethylene glycol)	Ethylene glycol is toxic – follow the manufacturer's instructions. For safe disposal consult the local regulations. Use a lid to reduce the dilution of the mixture caused by condensing water vapour from the air, and to maintain the cool down rate.
0°C to 50°C	80% water, 20% antifreeze (inhibited ethylene glycol)	
5°C to 95°C	Water*	Water can be used but care should be taken above 60°C as hot vapour can be dangerous. The equipments should not be used to boil water.
0°C to 100°C	Silicone fluid Viscosity ~20cs Flash point ≥230°C Fire Point ≥280°C	Dow Corning DC200/20 silicone fluid is a suitable liquid – follow the manufacturer's instructions. For safe disposal consult the local regulations.

\* See section 7.1 for further details

## 5.0 Operating procedures

---

### 5.1 Preparing the ecocool 100R for use

#### 5.1.1 Liquid level

Remove the lid and fill the tank to an appropriate level with a liquid suitable for your working temperature; see section 4.7 for recommended liquids.

Maximum fill level	140mm (10mm from the top of the tank)
Minimum fill level	105mm (45mm from the top of the tank)

If silicon oil is used, adjust the maximum and minimum fill levels to allow for thermal expansion and contraction of the liquid during operation to prevent overspill. Allow for any liquid in external circulation paths. If using liquids that can evaporate, then periodic checking and refilling should be completed. The fluid must cover the cooling coil to maintain the cooling power and prevent condensation. Refit the lid when filling is complete.

The low liquid level float switch will alarm if the liquid drops below the minimum level for safe operation of the heaters. The heating circulator will switch off the heating, cooling and pumping. Temperature control will stop.

#### 5.1.2 Tank lid

Always keeps the lid fitted when operating the equipment.



Take care when lifting and removing the lid as it may be hot. Steam and hot vapours can cause scalding.

#### 5.1.3 Setting the over-temperature thermostat

An over-temperature cut-out dial with a temperature scale is located at the top right of the heating circulator. The over-temperature probe independently monitors the bath temperature and switches the heater off if it goes above the cut-out threshold.

##### Coarse setting of the over-temperature thermostat

Align the temperature cut-out dial to the desired temperature on the marked scale. The chosen setting should be higher than the set working temperature to avoid operating the cut-out before the set temperature has been reached. If the alarm is triggered the sounder can be silenced by pressing either the **F** or **S** button once. To continue to use the heating circulator, the bath liquid must be allowed to cool by at least 5°C. Cooling can be achieved by either waiting for the liquid to cool naturally or by replacing the liquid. Once the liquid has cooled sufficiently, switch the equipment off, wait 10 seconds and switch it on again to clear the alarm. To avoid nuisance tripping ensure that the trip is set at least 5°C above the desired set working temperature.

##### Alternative setting of the over-temperature thermostat

Rotate the temperature cut-out dial to maximum (or at least a value above the level required) and configure the set temperature to the cut-out level required. Leave the bath to reach the set temperature and stabilise for at least 5 minutes. Turn the cut-out dial slowly anticlockwise until an over-temperature fault is displayed on screen and the alarm sounds continuously. This gives an over-temperature trip point at the set temperature. The audible alarm can be cancelled by pressing either the **F** or **S** button once.





To continue to use the heating circulator, let the bath liquid cool by at least 5°C, either naturally or by replacing the liquid, switch the equipment off, wait 10 seconds and switch it on again to clear the alarm. To avoid nuisance tripping the trip point needs to be set at least 5°C above the desired control temperature.

#### 5.1.4 Using the heating circulator pump

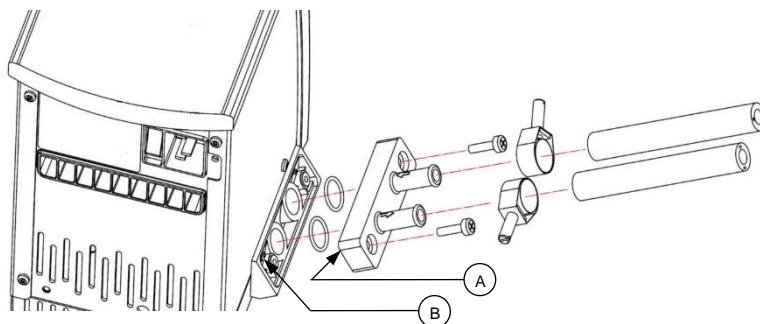
The heating circulator allows liquid to be pumped around a closed external system (not open to the atmosphere). It cannot be used for circulation through an external open tank. The pump is fitted with a blanking plate as standard. Fit a pump connector plate as shown below. Ensure o-rings are located in the grooves, use silicone grease to hold the o-rings in place. Note: the blanking/connector plates have a locating hole (see A below) to assist correct alignment onto the pump moulding. It is important to verify the hole is aligned with the corresponding locating pin (see B below) on the pump moulding. Failure to do so will result in a leaking connection. Retain the blanking plate for refitting when the pump is no longer required.

The equipment is supplied with insulated hose which is designed to operate at temperatures between -40°C to 100°C. Suitable high temperature hose (Grant Part No. HOSE 200) is recommended for temperatures above 100°C.



-  Always use pump connectors and hoses that are suitable for the operating temperature and liquid used. Check the pipe connections are secure.
-  Never disconnect any pipes or hoses while they contain very hot or very cold liquids or while the equipment is pumping.
-  Never use silicone oil with silicone tubing.
-  Switch off the equipment when connecting and disconnecting hoses

Pumping heat transfer liquid around an external system can lead to hazards that are outside the control of Grant Instruments. It is essential that the user conducts a risk assessment of the entire equipment installation to ensure that correctly rated materials have been used throughout and that the system can be used safely.

#### 5.1.5 Emptying the liquid tank

The refrigerated bath tank should be emptied to a safe level prior to moving. A drain tap is provided to allow convenient emptying. See section 5.2.2 and figure 3 for full details.

-  Liquid to be drained should not be below 10°C or above 50°C

### 5.1.6 Setting up and switching on

Follow instructions in section 5.1.4 to attach the pump connector plate and insulated hose. Before filling and switching on, attach the open end of the hose to the application, taking care to note the inlet and outlet.



Ensure all hoses are connected securely. Liquid will begin pumping immediately once the equipment is switched on.

Add the appropriate working liquid to the bath to at least the minimum recommended fill level such that the float level switch is fully raised.

For 230V equipment. Make sure the heating circulator power switch is in the ON position.

For 120V equipment. The refrigerated bath and heating circulator must be switched on separately. Note that the refrigerated bath will not operate until the heating circulator has started up.

When working at high temperatures, ensure the cables are not touching hot surfaces or air vents

Switch on the equipment using the power switch on the front of the refrigerated bath. The heating circulator motor will start immediately, and the buzzer will sound. The heating circulator will display `ECC` followed by the software version number. `r 100` will then be displayed to indicate the refrigerated bath is correctly responding. `ECC` will then be displayed to indicate the cooling mode. The display will then show the current liquid temperature. The equipment will start to control at the current Set Point temperature.

### 5.1.7 Eco mode cooling

The ecocool100R has variable power cooling as well as a heating system. This enables the system to achieve and maintain the required temperature using minimum energy without a loss in performance. The ecocool100r is preset to run in this energy-saving eco mode. The cooling can also be set of OFF or constant HIGH power. See section 5.2.9 to configure the cooling mode

## 5.2 Using the equipment

### 5.2.1 Setting the control temperature

The temperature of the circulation liquid is set using the **S** button on the heating circulator.

1. Whilst the display is showing the bath temperature, press the **S** button. This will cause the display to flash indicating that it can be set.
2. Use the main dial to set the desired temperature.  
*If no key is pressed for 10 seconds, then the display will revert back to showing the bath temperature and the set temperature will remain at its original value.*
3. Press the **S** button to store the requested value and the display will revert to showing the bath temperature.  
*If the temperature selected is higher than the current liquid temperature, the heater light will come on.*

### 5.2.2 Selecting liquid type

The type of liquid selected limits the temperature range available for safe operation of the equipment. It is important the liquid selected matches the actual liquid in the tank.

It is the user organisation's responsibility to assess the risks associated with the choice of heat transfer liquid chosen and to put in place safe working practises and appropriate protective equipment for personnel when considered necessary.

1. Press the **F** button four times – the display will show the current liquid type.
2. Use the main dial to select the required liquid.

Liquid	Set temperature range
H2O	5°C to 100°C
Oil	0°C to 100°C
LtL	-20° to 50°C

\* LtL = low temperature liquid, for example 50% water/50% glycol

3. Press the **S** button to set the liquid type and return to normal temperature display.
4. Change the Over Temperature thermostat to be approximately 5°C above the new working set point temperature. See section 5.1.3



To ensure protection the over-temperature cut-out must be set appropriately for the heat transfer liquid selected.



When changing the liquid from water to oil, ensure all residue of water is removed from the pump and hoses. There is a risk of scalding from boiling water.

### 5.2.3 Configuring a preset temperature

The equipment can be configured with three temperature presets to allow it to be conveniently run at frequently used temperatures. The method below is used to configure preset 1; the other presets can be set in a similar manner.

Be aware that once a preset has been saved, it will automatically operate once the steps below have been completed.

1. Press the **F** button on the heating circulator and rotate the dial until the display shows “t 1”.  
*The display will alternate between the preset number and its temperature.*
2. Press the **S** button to select the preset.
3. Use the dial to set the desired preset temperature.  
*If no key is pressed for 10 seconds then the display will revert back to showing the bath temperature and the preset temperature will remain at its original value.*
4. Press the **S** button to save the preset temperature.  
*The preset will automatically start as soon as the value is saved.*

Preset temperatures and set temperatures are limited to between -20°C and 100°C. The factory preset settings are shown in the following table.

Preset	Set temperature range
t-1	37°C
t-2	56°C
t-3	72°C

#### 5.2.4 Running a bath preset

1. Press the **F** button and rotate the dial until the display shows the correct preset.
2. Press the **S** button to select the preset.
3. Press the **S** button to set the bath to the preset temperature.

#### 5.2.5 Setting a countdown timer

The heating circulator includes a countdown timer in minutes which triggers an audible alarm on completion. The timer can be set between 1 minute and 6000 minutes (100 hours).

1. Press the **F** button twice – the display will show “[LOC]”.
2. Press the **S** button to select.
3. Use the main dial to select “01” and press the **S** button to select. The display flashes with time (in minutes) indicated. Rotate navigator control to set time required.
4. Press the **S** button to save and return to liquid temperature display with timer countdown started.

When the countdown clock is set the display alternates between bath temperature and time remaining in minutes.

When the countdown timer reaches zero the audible alarm will sound and the display will alternate between the water temperature and “End”. The alarm can be accepted by pressing the either the **F** or **S** buttons.

**Note: the equipment will continue to control at the set temperature after the timer reaches zero – the heater will not switch off.**

### 5.2.6 Cancelling the timer

The countdown timer can be easily cancelled.

1. Press the **F** button twice – the display will show “CLoc”.
2. Press the **S** button to select.
3. Use the main dial to select “Off” and press the **S** button to select. The display will revert to the bath temperature and the timer will be cancelled.

### 5.2.7 Setting a high temperature warning alarm

To set the level of the high temperature warning alarm, follow the steps below.

1. Press the **F** button three times – the display will show “ALAr”.
2. Press the **S** button to select.
3. Use the main dial to select “On” and press the **S** button to select. The display flashes the high temperature alarm value. Rotate the dial to set the high temperature alarm required.
4. Press the **S** button to save and return to liquid temperature.

If the high temperature alarm value is exceeded then the heating circulator will sound the buzzer intermittently and show “-AL-” on the display. The alarm can be acknowledged by pressing either the **F** or **S** buttons. However, the alarm is persistent and will trigger again if the temperature still exceeds the high temperature value. The alarm can be cancelled by following the steps above but using the dial to select “OFF” in step 3 and pressing the **S** button to confirm.

**Note: the high temperature alarm will not switch off the heater.**

### 5.2.8 Controlling the external pump power

An external pump, powered from the rear panel of the refrigerated bath can be switched on and off using this menu on the heating circulator:

1. Press the **F** button five times – the display will show “PUMP”.
2. Press the **S** button to select. The display will show the current mode
3. Use the main dial to select the required mode of operation.

Mode	Operation
OFF	Pump permanently off
On	Pump permanently on

3. Press the **S** button to save.

Note that if a pump is already connected, it will start pumping immediately. The heating circulator will remember the pump setting when switched off.



### 5.2.9 Selecting cooling mode

The refrigeration cooling mode is set to energy saving ECO mode at the factory. The user can change this setting if required:

1. Press the **F** button on the heating circulator six times – the display will show "COOL".
2. Press the **S** button to select. The display will show the current mode
3. Use the main dial to select the required mode of operation.

Mode	Operation
OFF	Cooling permanently off
ECO	Energy saving eco mode
HI GH	Cooling permanently on maximum power

3. Press the **S** button to save

Note: The cooling mode currently selected is displayed during the equipment power on sequence.

### 5.2.10 Completing a calibration

The equipment allows a two-point calibration to be completed. The calibration menu can be accessed by pressing the **F** and **S** buttons on the heating circulator simultaneously for about 5 seconds.

The calibration temperatures are constrained by the temperature limits of the liquid type setting. Calibration should be carried out using a traceable reference thermometer with an accuracy of at least 0.1°C. This thermometer should be held securely in the centre of the bath or vessel.

The calibration of the equipment is performed by setting, a low temperature calibration point and a high temperature calibration point. The high temperature calibration point must be at least 40°C higher than the low temperature point.

Calibration points should be chosen to be at critical experimental temperatures where accuracy is important or, alternatively, at the extremes of the working range of used temperatures.

If only the low temperature calibration point is set; then the calibration will be performed between this point and 100°C with the offset decreasingly linearly. If only the high temperature calibration point is set; then the calibration will be performed between 0°C and this point with the offset decreasingly linearly.

In order to achieve an accurate calibration it is important to ensure that the liquid temperature is stable. If following calibration the temperature indicated on the heating circulator is not in accordance with the thermometer the equipment should be reset.

#### Setting the low temperature offset

1. Adjust the set temperature to the required low temperature calibration point.
2. Allow the equipment to stabilise for at least 5 minutes after a stable temperature condition has been achieved.
3. Measure the liquid temperature by placing a reference thermometer into the centre of the bath.

4. Press the **F** and **S** buttons simultaneously for approximately 5 seconds until "LCL" is shown.
5. Press the **S** button to select.
6. Use the main dial to update the display to show the temperature on the reference thermometer.
7. Press the **S** button to store the temperature.  
*Press the F button to cancel the calibration.*
8. Press the **F** button to return to the liquid temperature display.

#### **Setting the high temperature offset**

1. Adjust the set temperature to the required high temperature calibration point.
2. Allow the equipment to stabilise for at least 5 minutes after a stable temperature condition has been achieved.
3. Measure the liquid temperature by placing a reference thermometer into the centre of the bath.
4. Press the **F** and **S** buttons simultaneously for approximately 5 seconds until "LCL" is shown.
5. Rotate the dial until the display shows "HCL" and press the **S** button to select.
6. Use the main dial to update the display to show the temperature on the reference thermometer.
7. Press the **S** button to store the temperature.  
*Press the F button to cancel the calibration.*

#### **5.2.11 Restoring factory calibration settings**

The restore factory calibration allows the equipment settings to be reset if there is a problem during calibration or you wish to cancel any of the calibration settings.

1. Press the **F** and **S** buttons simultaneously for approximately 5 seconds until "LCL" is shown.
2. Rotate the dial until the display shows "r5t" and press the **S** button to select.
3. Press the **S** button three times (the display will show "Con\_3", "Con\_2", "Con\_1" and sound the buzzer to confirm the factory reset has been completed).

#### **5.2.12 Adjusting display brightness**

If required, the brightness level of the display can be adjusted over a range of 20% to 100%

1. Press **F** and **S** buttons on the heating circulator simultaneously for approximately 5 seconds until the display shows "LCL".
2. Rotate the dial until the display shows "d 5P" and press the **S** button to select.
3. Rotate the dial between the settings and select required brightness  
*The displayed values show the display brightness*
4. Press **S** button to save the value.
5. Press **F** button to return to the normal temperature display.

## 6.0 Technical specifications

---

### 6.1 Operating conditions

Ambient temperature range	5 to 40°C
Altitude above sea level	Up to 2,000m (6,500ft)
Operating environment	Indoor use only
Maximum relative humidity	80% RH up to 31°C decreasing to 50% RH at 40°C

### 6.2 Electrical details

Mains supply: 220-240V @ 50 or 60Hz\* or 110-120V @ 50/60Hz

Pollution degree: 2

Installation category: II

\*220-240V heating circulators can only operate at a single mains frequency. Check the rating plate of the heating circulator.

Mains supply voltage fluctuations are not to exceed  $\pm 10\%$  of the nominal supply voltage.

### 6.3 Performance

Specification		ecocool 100R	
		ecocool 100R AUS	ecocool 100R US
Typical cooling power at an ambient temperature of 20°C	@ 20°C	250W	
	@ 0°C	200W	
	@ -10°C	100W	
	@ -20°C	50W	
Stability (DIN 12876) @ -10°C		$\pm 0.05^\circ\text{C}$	
Settable temperature range		-20°C to 100°C	
Tank capacity		4.5L	
Top opening		120 x 150mm	
Tank depth		150mm (usable 140 leaving 10mm clear)	
Liquid depth min/max		105/140mm	
Weight		29kg	
Max pump head pressure		250mBar	
Max pump flow rate		17L/min	
Safety high temperature limit		Adjustable cut-out above 20°C	
Max current consumption (both equipment excluding external pump)		7A	18A*
Heater power		1.3kW	1.4kW

\*Combined rating of both the refrigeration bath and heating circulator.

### 6.4 Storage and transportation

Store and transport in original packaging. Temperature range -20°C to +60°C

---

## 7.0 Technical Tips

---

### 7.1 Which water should you use in your equipment?

For the long-term reliability of the equipment it is important to use oxygenated water that is free from ions and minerals that can cause corrosion of stainless steel. We recommend the use of distilled water and de-ionised water from modern ion exchange systems that do not use salt back flushing to regenerate the ion-exchange cartridges.

Stainless steel is protected from corrosion by a layer of chromium oxide. If the chromium oxide layer is damaged, oxygen present in water can reform the oxide layer. If the water is distilled or de-oxygenated, and the oxide layer is damaged, ions can corrode the stainless steel tank. If a water bath has been unused for some time, or the water has been boiled, we recommend changing to fresh distilled water or the correct type of de-ionised water as explained below.

Water normally contains calcium or magnesium ions. De-ionised water has most ions removed as indicated by its conductivity level; the purer the water the lower the conductivity. It is important to use only de-ionised water from an ion exchange system with replaceable cartridges. Do not use de-ionised water generated from an ion-exchange system that incorporates a salt back-flush system to regenerate the ion-exchange resin as this can leave sodium ions that are very corrosive to stainless steel.

### 7.2 How to prevent rust in the equipment

Most Grant tanks, and other parts which are immersed in water, are made from type 304 stainless steel. Type 304 stainless steel is an extremely versatile general-purpose grade of stainless steel. It is the excellent forming characteristic that has made this grade dominant in the manufacture of laboratory and industrial water baths, as well as domestic sinks and saucepans. Type 304 stainless steel is highly suitable for applications where hygiene is important; it exhibits good heat resistance and excellent resistance to corrosion.

However, despite resistance to general surface corrosion, stainless steel is susceptible to specific types of corrosion, in particular pitting (small pin hole style corrosion) and stress corrosion cracking. It can also undergo general corrosion in specific environments, such as one containing hydrochloric or sulphuric acids.

Stainless steel is protected by its high content of alloying elements, primarily chromium and nickel. Chromium is the most important with respect to corrosion resistance, although the nickel assists in allowing the chromium to do its job. The chromium forms an oxide layer on the surface of the steel, which inhibits further oxidation. This layer adheres extremely well to the metal substrate, but it is essential that it remains intact, and must be protected from various forms of damage.

If the surface chromium oxide layer becomes damaged, oxygen present in water can partially reform the oxide layer, so it is advisable to ensure that water is always fresh and well oxygenated. Baths that will be out of use for an extended period should be emptied, and all moisture should be wiped from the bottom of the tank.

In some cases, a brown layer may appear on the surface of a stainless steel tank. In most cases this is not rust, but it may be a surface deposit of minerals from the local water supply, it can also be caused by ferrous particles or salts that have fallen into the tank. These surface deposits can usually be removed by using a household metal polish.

### **7.3 How to prevent algae and bacteria?**

The equipment provides the ideal environment for the growth of micro-organisms. If left uncontrolled the growth of these organisms can result in a range of serious problems and health risks from pathogenic bacteria.

The growth of algae on the surfaces will cause bio fouling which can reduce performance.

Micro-organisms that produce acidic metabolic by-products can cause bio-corrosion by depolarisation of metal surfaces.

There are a number of biocides available on the market.

## 8.0 Warranty information

---

When used in laboratory conditions according to this manual, this product is guaranteed for THREE YEARS against faulty materials or workmanship.

Extended warranty for year five can be purchased by contacting our sales department at [salesdesk@grantinstruments.com](mailto:salesdesk@grantinstruments.com).

## 9.0 Maintenance and service

---

### 9.1 Routine maintenance

**The refrigerated bath contains a flammable refrigerant:**



- Do not use mechanical devices or other means to accelerate defrosting: either turn the equipment off or set it to ambient temperature and wait until all the ice has melted.
- Do not damage the refrigerant circuit.

The over-temperature cut-out on the heating circulator should be checked periodically by turning the over-temperature dial with a screwdriver anticlockwise until the alarm lamp illuminates. The heating circulator will also sound a buzzer and “Cut” will be shown on the display. The over-temperature dial should then be turned to the maximum setting without the alarm cancelling. The heating circulator should be powered off and back on to confirm that the cut-out can be reset correctly. If the alarm lamp fails to illuminate when the value indicated on the over-temperature dial is more than 10°C below the current temperature as indicated by the main display, then the equipment should be checked by a competent person.

The float liquid level protection should also be checked periodically by lowering the level of liquid in the bath and noting that the equipment cuts out with the top turn of the heater coil still immersed in the liquid.

When hoses are fitted to the pump they should be inspected periodically and replaced as necessary to avoid hose failure.

No other routine maintenance is required.

### 9.2 Cleaning

Regular maintenance of the refrigerated bath is important to allow it to perform to its specification and is required for validity of the warranty.

A removable grille enables easy access to the condenser for cleaning. Cooling power will be reduced if the fins become clogged with dust. The condenser fins (see section 4.2.2, figure 3) should be examined monthly and, if necessary, use a vacuum cleaner nozzle and soft brush to remove the dust.

Take care not to damage the condenser fins during cleaning. Always replace the condenser grille following cleaning



Allow the equipment to cool before cleaning the condenser fins



Unplug the equipment from the mains supply before cleaning

Clean the outside of the equipment with a soft damp cloth, using water only. Do not use chemical cleaning agents. Before using any other cleaning or decontamination method, check with Grant Instruments or your local representative to make sure that the proposed method will not damage the equipment.

To aid cleaning the heating circulator it can be removed from the refrigerated bath. Unfasten the thumbscrew at the rear of the refrigerated bath and lift the heating circulator and top plate.

Scale on immersed parts can be removed using chemical de-scaling products designed for use on equipment that has metal parts. De-scaling products may be toxic and the manufacturer's instructions should always be followed

### 9.3 Fuses

Both the heating circulator and refrigerated bath fuses are internal and should not need to be replaced. Please contact the Grant Instruments service department if the equipment has a fuse fault.

The external pump power outlet has a user replaceable fuse. Replacement fuses must be 20mm x 5mm Quick blow type with a F2.5A L 250V rating.

Fuse replacement should only be carried out by a competent person.

### 9.4 Replacing the mains cord

This equipment must only be used with an appropriately approved cord set acceptable for the country in which the equipment is intended to be used.

The mains cord set must be suitably rated for the equipment it is intended to be used with, refer to the equipment rating label for further details.

No user replaceable parts, if the cord set is damaged do not operate the equipment, disconnect from the supply immediately and contact Grant Instruments or your authorised service agent for replacement.

#### Guidance information table

Country	Cord type	Mains Plug	Appliance coupler
US	SJTW 14AWG 105°C	NS-3P	Not applicable
Canada			Not applicable
UK	H05VV-F 3G1.5mm <sup>2</sup> , 300/500V 90°C	BS 1363	IEC 60320, Type C20
Europe		IEC 60309	IEC 60320, Type C20

### 9.5 Routine safety tests

If routine tests are to be made, we recommend a test of the integrity of the protective earth conductor and an insulation test at 500V DC. Routine flash tests are not recommended for any electrical equipment, because repeated high voltage tests degrade insulation materials.

## 9.6 Disposal



Warning: equipment contains a flammable refrigerant.

The refrigerated bath contains flammable refrigerant gas which must NOT be discharged into the atmosphere. At the end of the equipment's working life, either have the gas removed safely by using refrigerant recovery equipment or return the equipment to Grant Instruments for disposal.

## 9.7 Service

If service is required, switch off the equipment and contact Grant Instruments or your local representative for repairs.

Please note all returned equipment must be accompanied by a Return Materials Authorisation (RMA) number, obtainable by contacting the Grant service department (details below).

Service Department  
Grant Instruments (Cambridge) Ltd  
Evolution House  
Unit 2, Durham Way  
Royston Gateway  
Royston  
SG8 5GX UK

Tel: +44 (0) 1763 260 811  
E-mail: [service@grantinstruments.com](mailto:service@grantinstruments.com)









## 10.0 Optional accessories

### 10.1 Alternative pump

The heating circulator has a built-in pump. If greater head (pressure) is required, choose from two accessory pumps and the appropriate pump lid. Visit the Grant website [www.grantinstruments.com](http://www.grantinstruments.com) for full technical specifications.

Pump Product	Description	
VTP1-LT	Max head pressure: 1000mBar Max flow rate: 9 L/min	
VTP1L-LT	Max head pressure: 1000mBar Max flow rate: 9 L/min 120V	
VTP2-LT	Max head pressure: 1700mBar Max flow rate 12 L/min	

### 10.2 Pump connectors and other accessories

Connectors	Description	
P-M6	Replacement plastic pump inlet/outlet connector, fits 9mm ID, T° range -50 to 200°C	
P-M11	Replacement plastic pump inlet/outlet connector, fits 15mm ID, T° range -50 to 200°C	
M-M16	Stainless steel pump inlet/outlet connector, M16 x 1 male, T° range -50 to 200°C	
M-SR4	Metal pump inlet/outlet connector, dual seal super rapid 4mm, fits semi rigid tubing 4mm OD, T° range -20 to 100°C	
M-SR6	Metal pump inlet/outlet connector, dual seal super rapid 6mm, fits semi rigid tubing 6mm OD, T° range -20 to 100°C	
M-SR8	Metal pump inlet/outlet connector, dual seal super rapid 8mm, fits semi rigid tubing 8mm OD, T° range -20 to 100°C	
M-HB7	Metal pump inlet/outlet connector, hose barb 7mm, fits flexible tubing 7mm ID, T° range -40 to 120°C	
M-HB9	Metal pump inlet/outlet connector, hose barb 9mm, fits flexible tubing 9mm ID, T° range -40 to 120°C	
M-HB12	Metal pump inlet/outlet connector, hose barb 12mm, fits flexible tubing 12mm ID, T° range -40 to 120°C	
M-UC	Metal pump inlet/outlet plate, ¼" BSP/G1/4 female, T° range -50 to 200°C	
HOSE200	2 metre, high temperature hose kit	

IQOQ ecocool 100R	IQOQ documentation for the ecocool 100R	
PQ ecocool 100R	PQ documentation for the ecocool 100R	

A full listing of equipment accessories and options is available in the Grant Scientific Reference Catalogue (a copy of which is available upon request) and on the Grant website at [www.grantinstruments.com](http://www.grantinstruments.com).

## 11.0 Troubleshooting

Symptom	Possible cause	Action required
Display shows "E07"	Refrigerated bath is not detected by heating circulator	Check communications lead is connected to control and refrigerated baths Check refrigerated bath is connected to mains power and switched on.
	Refrigerated bath has overheated	Wait for compressor to cool, when thermostat will reset and compressor will switch on again.  Remove any vent obstructions and carry out routine cleaning (see section 9.2)
Display shows "E08"	Refrigerated bath is connected but not powered	Check mains power to refrigerated bath.
Display shows "Hot"	Chiller in pre-over heating condition	Switch off equipment. Check air vents are not restricted. Clean dust from condenser fins. See Section 9.
Display shows "Cut"	Over-temperature cut-out has operated	Check the set temperature is correct and that the over-temperature cut-out temperature is set at least 5°C above the set temperature. Refer to section 5.1.2 for setting instructions.  If the over-temperature cut-out temperature is correctly set but the equipment still shows a "Cut" alarm then the equipment has an internal fault and must be repaired before it is used again.
Temperature does not rise when expected	Set temp is lower than liquid temp	Check that the bath set temperature is correct (see section 5.2.1).
Temp continues to rise when not expected	Set temp is higher than liquid temp	Check that the bath set temperature is correct (see section 5.2.1).
Display shows "E09"	Refrigerated bath has stopped cooling	Check communications lead is connected to control and refrigerated baths.
	Refrigerated bath has overheated	Switch off refrigerated bath and allow to cool
Alarm light on	Over-temperature cut-out has operated	Check the over-temperature cut-out is set appropriately (see section 5.1.2).
	Low liquid level float switch has operated	Check that the liquid level in the bath is adequate.
Set temperature too restricted	Liquid type set does not allow required set point	Change to different liquid type (see section 5.2.2).

Display shows "FLot"	Liquid level has dropped below minimum level	Check that the liquid level in the bath is adequate.
Display shows "-AL-"	High temperature warning alarm has tripped	Check that the bath set temperature is correct (see section 5.2.1). Check that high temperature alarm is correct (section 5.2.7). Check that the liquid level in the bath is adequate (see section 6.3 for minimum fill levels).
Display shows "Er H"	Incorrect calibration value	The high temperature calibration point is less than 40°C above the low calibration point – choose a higher temperature (see section 5.2.10).
Display shows "Er L"	Incorrect calibration value	The low temperature calibration point is less than 40°C below the high calibration point – choose a lower temperature (see section 5.2.10).
Display shows "Er d"	Incorrect calibration value	The calibration value is greater than 10°C from the set point – check thermometer reading and set point (see section 5.2.10).
Display shows "OPEN"	Faulty internal temperature probe	Have a competent person check the probe for an open circuit fault or contact Grant.
Display shows "Short"	Faulty internal temperature probe	Have a competent person check the probe for a short circuit fault or contact Grant.
Equipment showing erratic temperatures	Calibration values not set correctly	Restore the factory calibration settings (see section 5.2.11) then re-calibrate if required (see section 5.2.10).
Display shows "Hot"	Heating water at or near to boiling without lid  Heating very large volumes of liquid with large thermal losses	Fit a lid to reduce thermal losses and leave equipment running with the "Hot" warning present. If the alarm has not cleared within 1 hour contact Grant.  Add measures to reduce thermal losses and leave equipment running with the "Hot" warning present. If the alarm has not cleared within 1 hour contact Grant.
Display shows "Errt"	Internal PCB fault	Have a competent person check the product or contact Grant.
Display shows "SELF"	Internal heating circuit failure	Have a competent person check the product or contact Grant.
Stirrer motor not rotating	Stirring propeller or pump impeller is obstructed  Faulty motor	Clear obstruction.  Have a competent person check the motor or contact Grant.

Display shows “EOLd”	Accidentally entered manufacturer reset mode	Warning can be cleared by pressing <b>S</b> button, but note that all settings (including any factory calibration) will be reset to the default values. Contact Grant Instruments service department for assistance if required.
Display shows “FACT”	manufacturer factory setting menu	There are no user configuration options in this menu. Press the <b>F</b> button to return to the home screen
Display shows “????”	manufacturer factory setting menu	There are no user configuration options in this menu. Press the <b>F</b> button to return to the home screen

For any other errors or service requests, please contact Grant Instruments service department.

## 12.0 Contact Grant Instruments

---

At Grant we are continuously trying to improve the performance we offer our customers. If you have any feedback on Grant’s products or services we would like to hear from you. Please send all feedback to:

Quality Manager  
Grant Instruments (Cambridge) Ltd  
Evolution House  
Unit 2, Durham Way  
Royston Gateway  
Royston  
SG8 5GX UK

Tel: +44 (0) 1763 260 811  
E-mail: [support@grantinstruments.com](mailto:support@grantinstruments.com)

## 13.0 Compliance

---

### Waste Electrical and Electronic Equipment (WEEE)



This product marked with the crossed-out wheelee bin symbol indicating it must not be disposed of with unsorted waste. Safe recycling of WEEE helps conserve natural resources and protect human health.

Grant Instruments complies fully with the UK Waste Electrical & Electronic Equipment (WEEE) regulations 2013. We are a member of the B2B compliance scheme (Scheme Approval Number WEE/MP3338PT/SCH), which handle our WEEE obligations on our behalf. Grant Instruments have been issued with a unique registration number by the Environmental Agency, this reference number is WEE/GA0048TZ.

For information regarding WEEE collections in the UK please contact our B2B Compliance Scheme directly on 01691 676 124 or [www.b2bcompliance.org.uk](http://www.b2bcompliance.org.uk)

In the EU, Grant Instruments complies with WEEE Directive 2012/19/EU. Contact your local equipment supplier for WEEE collections.

### Restriction of substances hazardous to health (RoHS)

This product complies with the requirements of the UK Restriction of the Use of Certain Substances in Electrical and Electronic equipment Regulations 2012 and the EU RoHS Directive (2011/65/EC including 2015/863). This means the products are free of Lead and other hazardous substances covered by the directive.

### Electrical safety and electromagnetic compatibility

This product complies with the requirements of the UK Electrical Equipment (Safety) Regulations 2016 and the European Union Low Voltage Directive (2014/35/EC) for Electrical safety.

This product complies with the requirements of the UK Electromagnetic Compatibility Regulations 2016 and the European Union EMC directive (2014/30/EC).

### Refrigerant and F-Gas regulations

The ecocool 100R is hermetically sealed equipment containing HC refrigerant R290

Refrigerant charge: 0.04 Kg  
CO<sub>2</sub> equivalent: 0.0002 Tonnes  
Refrigerant must be disposed of according to local regulations

### REACH Regulation

This product does not contain any Substances of Very High Concern (SVHCs) at greater than 0.1% that have to be identified in accordance with Regulation (EC) No 1907/2006 and therefore does not have an entry in the SCIP database.

## Notes

---



**Grant Instruments (Cambridge) Ltd**  
Evolution House, Unit 2  
Durham Way  
Royston Gateway  
SG8 5GX  
UK

Tel: +44 (0) 1763 260811  
[salesdesk@grantinstruments.com](mailto:salesdesk@grantinstruments.com)  
[www.grantinstruments.com](http://www.grantinstruments.com)

**Representative in the European Union**  
Grant Instruments Europe B.V  
Strawinskylaan 411  
WTC, Tower A, 4th Floor  
1077 XX AMSTERDAM  
THE NETHERLANDS

[grant@eu.grantinstruments.com](mailto:grant@eu.grantinstruments.com)